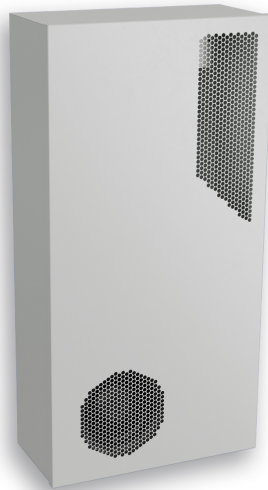

Table of Content 581000001

1. User manual	2
2. Legal regulations	3
3. Safety instructions	4
4. Functional principle	5
5. Technical data	5
6. Performance graph	6
7. Mounting	7
8. Cut Out Dimension	8
9. Electrical Connection	9
10. Controller	10
11. Wiring Diagram	11
12. Taking into Operation	12
13. Trouble Shooting	12
14. Maintenance & Cleaning	12
15. Transport & Storage	13
16. Parts supplied / Spare parts / Accessories	14



1. User manual

This instruction manual contains information and instructions to enable the user to work safely, correctly and economically on the unit. Understanding and adhering to the manual can help one:

- Avoid any dangers.
- Reduce repair costs and stoppages.
- Extend and improve the reliability and working life of the unit.

PLEASE ENSURE TO USE THE RIGHT VERSION OF THE INSTRUCTION MANUAL SUITABLE FOR YOUR UNIT.

Intended use

The unit is to be used exclusively for the dissipation of heat from control cabinets and enclosures (stationary, not moving) in order to protect temperature sensitive components in an industrial environment. To meet the conditions of use, all the information and instructions in the instruction manual must be adhered to.



General danger

Indicates compulsory safety regulations which are not covered by a specific pictogram such as one of the following.



High electric voltage

Indicates electric shock danger.



Important safety instruction

Indicates instructions for safe maintenance and operation of the unit.



Attention

Indicates possible burns from hot components.



Attention

Indicates possible damage to the unit.



Instruction

Indicates possible danger to the environment.

2. Legal regulations

Liability

The information, data and instructions contained in this instruction manual are current at the time of going to press. We reserve the right to make technical changes to the unit in the course of its development. Therefore, no claims can be accepted for previously delivered units based on the information, diagrams or descriptions contained in this manual. No liability can be accepted for damage and production caused by:

- Disregarding the instruction manual
- Operating error
- Inappropriate work on or with the unit
- The use of non-specified spare parts and accessories
- Unauthorised modifications or changes to the unit by the user or his personnel

The supplier is only liable for errors and omissions as outlined in the guarantee conditions contained in the main contractual agreement. Claims for damages on any grounds are excluded.

3. Safety instructions

Upon delivery the unit is already meeting current technical standards and can therefore be safely taken into operation. Only authorised personnel is allowed to work on the unit. Unauthorised personnel must be prohibited from working on the unit. Operating personnel must inform their superiors immediately of any malfunction of the unit.

Please note that before starting to work on or with the unit, a procedure must be carried out inside the cabinet on which the unit is to be mounted.

Before commencing work inside the cabinet, the control cabinet manufacturer's instruction must be read with regards to:

- Safety instructions.
- Instructions on taking the cabinet out of operation.
- Instructions on the prevention of unauthorised cabinet reconnection.

The electric equipment meets the valid safety regulations. One can find dangerous voltages (above 50 V AC or above 100 V DC)

- Behind the control cabinet doors.
- On the power supply in the unit housing.

The unit has to be operated according to the type plate and the wiring diagram, and must be protected externally from overloading and electrical faults via suitable protective devices.



Danger through incorrect work on the unit

The unit can only be installed and maintained by technical competent and qualified personnel, using only supplied material according to the supplied instructions.



Danger from electrical voltage

Only specialised personnel are allowed to maintain and clean the unit. The personnel must ensure that for the duration of the maintenance and cleaning, the unit is disconnected from the electrical supply.



Attention

Damage to the unit through the use of inappropriate cleaning materials. Please do not use aggressive cleaning material.



Instruction

Damage to the environment through unauthorised disposal. All spare parts and associated material must be disposed according to the environmental laws.

4. Functional principle

5. Technical data

Order Number	581000001
Heat exchanger performance	100 W/K
Operating Temperature Range	-25°C - 65°C
Air flow volume (system / unimpeded)	Ambient air circuit: 525 / 1000 m ³ /h Cabinet air circuit: 500 / 1000 m ³ /h
Mounting	Wall mounted
Housing Material	Mild steel, powder coated
Dimensions A x B x C (D+E)	914.4 x 460 x 218 mm
Weight	25.5 kg
Voltage / Frequency	230 V ~ 50/60 Hz
Starting current	6 A
Max. current	2 A
Max. power	287 / 460 W
Fuse	4 A (T)
Connection	4 pole terminal block for electrical connection 5 pole terminal block for signals
Ingress Protection	IP 56
Approvals	CE

6. Performance graph

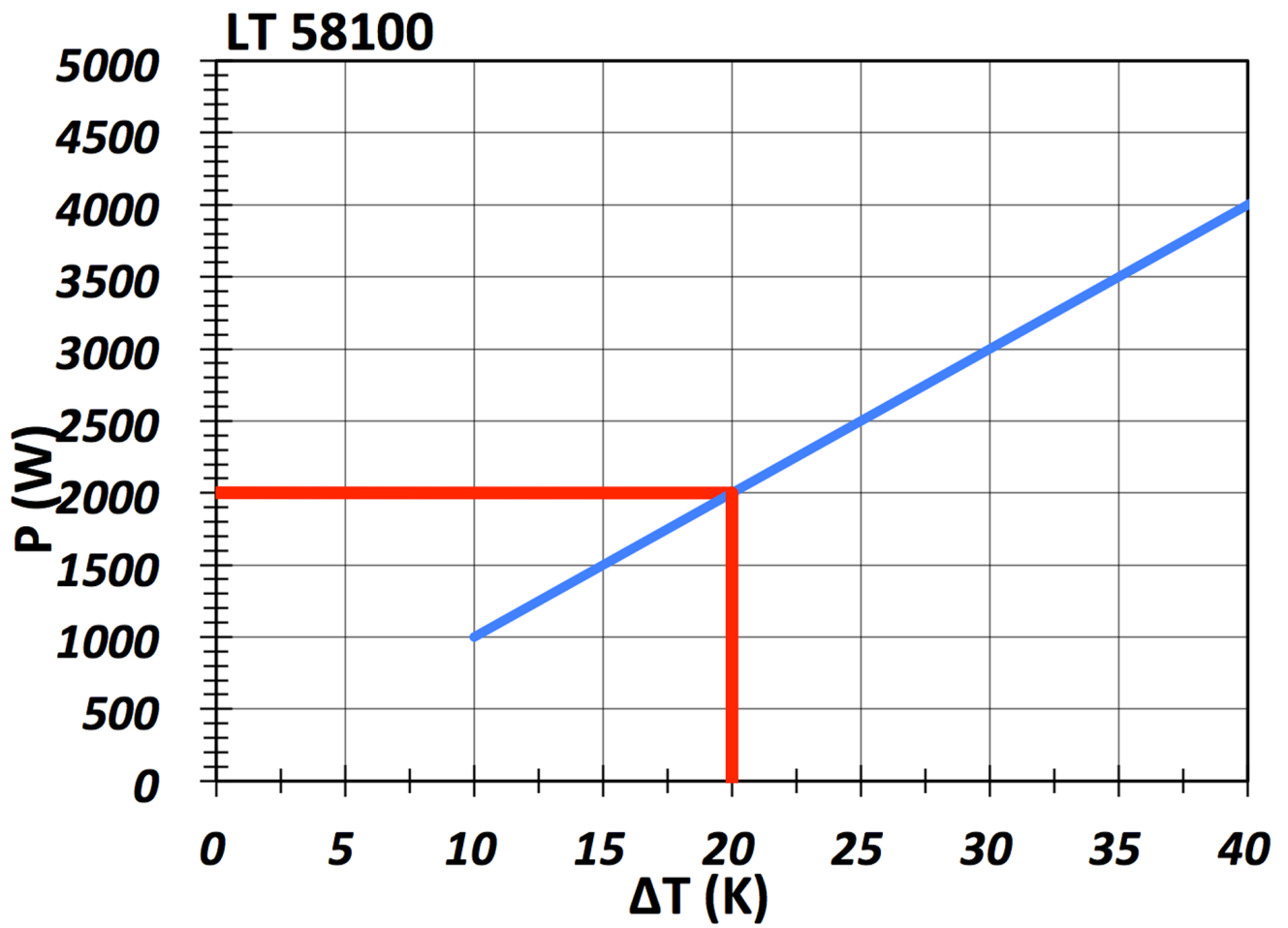

7. Mounting



Danger from electrical voltage

The unit must be mounted by specialist personnel (qualified electricians). The personnel must ensure that the cabinet is disconnected from the electrical supply for the duration of the mounting operation. Therefore take the cabinet out of operation, following the relevant instructions before mounting work commences.



Danger through incorrect work on the unit. Only specialists are allowed to put the unit into operation.

Mounting preparations

Several points must be checked before the unit can be mounted. These checks must be made to ensure safety and the trouble-free operation of the unit. These checks must be carried out with absolute thoroughness to ensure that the unit works perfectly.

Transport damage check

On delivery the carton containing the unit must be examined for signs of transport damage. Any transport damage to the carton could indicate that the unit itself has been damaged in transit which in the worst case could mean that the unit will not function.

Location and space requirements

The location of the cabinet must allow for sufficient air circulation to and from the unit. The unit should be mounted roughly vertically.

Sealing

To guarantee that the unit works perfectly ensure that, the control cabinet is completely sealed (to min. IP54 to EN 60529) and a good seal exists between the control cabinet and the unit. If necessary the cabinet mounting surface should be reinforced.

8. Cut Out Dimension

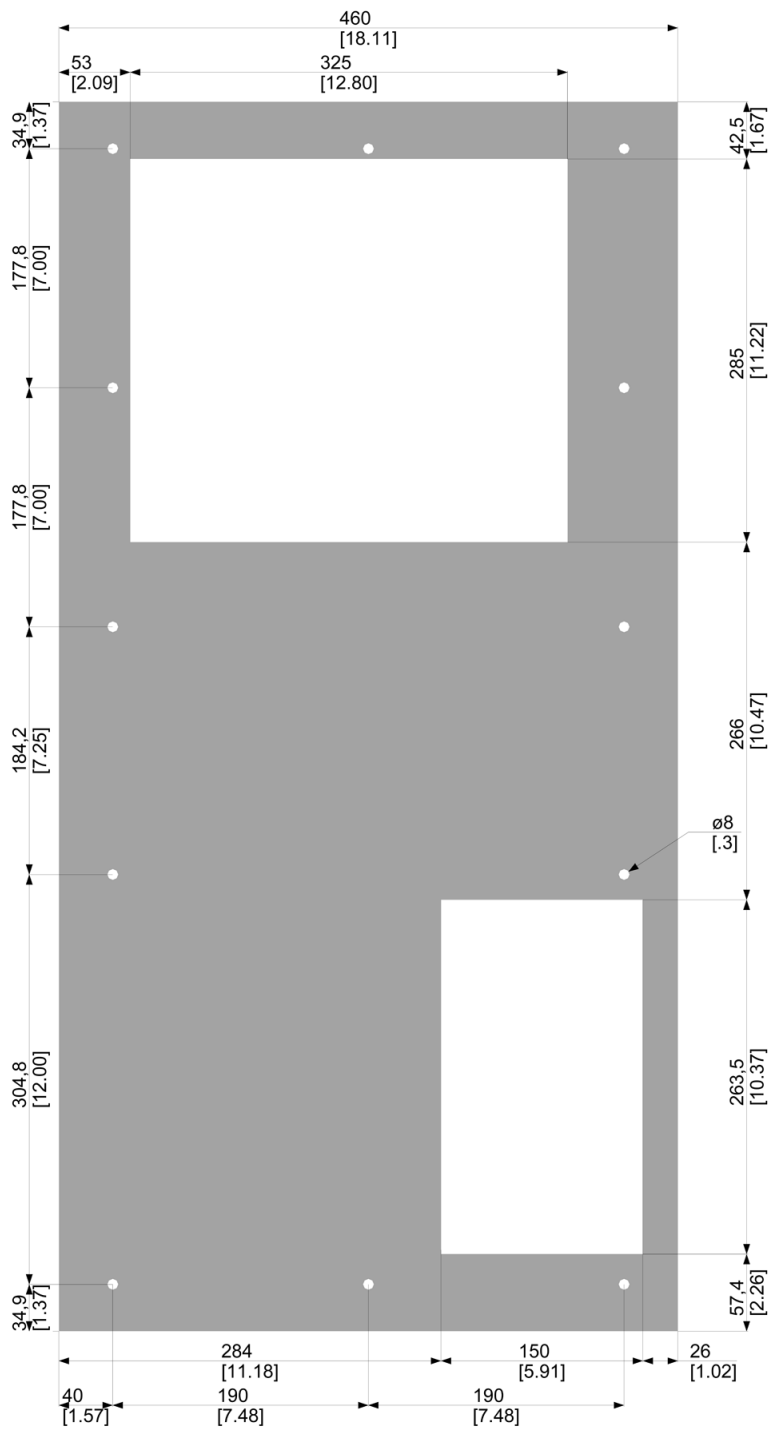

9. Electrical Connection



High electric voltage present. Installation, maintenance, cleaning and any other work must be carried out by qualified personnel only. The personnel must ensure that for the duration of this work the unit and the cabinet are disconnected from the electrical supply and protected against unauthorised/accidental reconnection.

Connection to the main electrical supply

To connect the unit to the mains proceed as follows:

- Take the control cabinet out of operation in the prescribed manner.
- See the connection details on the circuit diagram.

[FansRotateClockwise]

- Connect the unit to the mains.
- Take the control cabinet back into operation in the prescribed manner.
- Power consumption and start-up current are stated on the data label and under technical data.

10. Controller

The unit is equipped with a temperature controller which regulates the function of the air-conditioning cycle. At normal working conditions the display shows the temperature inside the enclosure. The cooling set point for the interior of the enclosure (parameter St / St1) is pre-set at 35°C and can be adjusted between 10°C and 60°C.

To change the cooling set point St/St1:

1. Press 'Set' till St/St1 appears on the display
2. Press the Up/Down buttons to adjust the temperature setting
3. Press 'Set' to save the new setting

To change the heating set point St2 (units with internal heater only):

1. Press 'Set' till St1 appears on the display and release the button
2. Press again 'Set' till St2 appears on the display
3. Press the Up/Down buttons to adjust the temperature
4. Press set to save the new setting

Important Note: when changing settings ensure that: $(St2 + 5K) < St1$

The unit also has a potential free high temperature alarm relay (normally closed configuration) that is pre-set to switch when the enclosure temperature exceeds 55°C. If necessary, the alarm relay configuration and the set point can be changed via the controller's parameters. Kindly contact your nearest service / sales partner for further details on how to change these parameters.

11. Wiring Diagram

Power connector (X1)

- 1 L1
- 2 /
- 3 N
- 4 PE

Signal connector (X2)

- 1 /
- 2 Alarm (NC)
- 3 Alarm (NC)
- 4 Door contact
- 5 Door contact

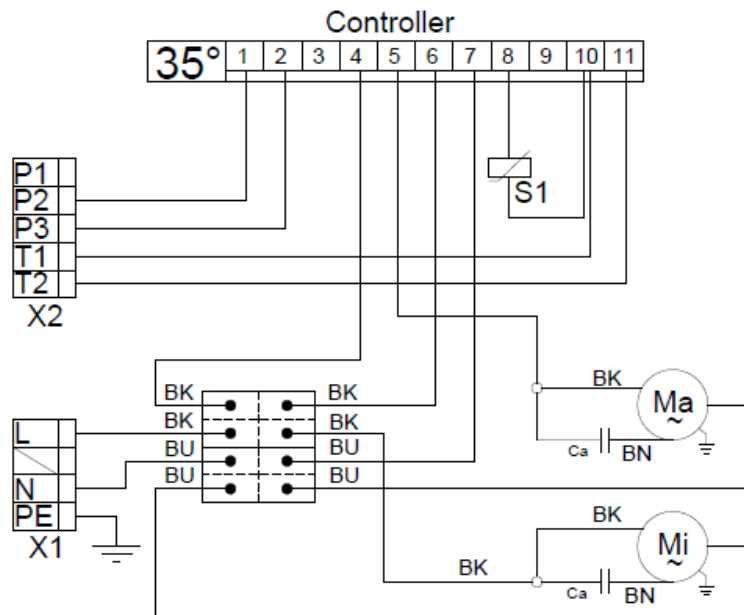

Part List:

- | | |
|--|---|
| X1 - Power Connector | M _i - Internal Blower |
| X2 - Signals Connector | M _a - Ambient Blower |
| S1 - Temperature Sensor Probe | C _a - Capacitor for Ambient Blower |
| C _i - Capacitor for Internal Blower | |

5960030793/a

12. Taking into Operation

As described before the unit is controlled in relation to the cabinet internal temperature. The required cabinet temperature can be set on the potentiometer on the controller. The temperature adjustment range is between 0°C (left-hand stop) and 60°C (right-hand stop). The thermostat is pre-set at 35°C.

To adjust the cabinet internal temperature proceed as follows:

- Remove the MCB access plate on the front of the unit.
- Using a screw driver turn the adjustment wheel on the potentiometer "TEMP" slightly to the right (higher) or to the left (lower).
- Please note that the setting for the alarm signal should be at least 5 - 10°C higher than the setting for the cabinet internal temperature.

Check that the new adjustment meets the necessary requirements. If necessary, repeat the procedure. Inspect and if necessary replace the MCB access plate sealing tape.

13. Trouble Shooting

In case of a fault log on to our website www.seifertsystems.com to locate your nearest servicing office or find your nearest contact in the chapter "contacts" in this manual.

14. Maintenance & Cleaning



Danger from electrical voltage

Maintenance and cleaning must be carried out by specialists (electricians). The personnel must ensure that for the duration of this work the unit and the cabinet are disconnected from the electrical supply and protected against unauthorised reactivation.



Danger through incorrect work on the unit.

The instructions in the cabinet manufacturer's manual must be adhered to!



Damage to the unit through incorrect maintenance and repair! Maintenance and repair must be carried out by the manufacturer or another specialist.

Fan replacement

The rated life expectancy of the fan is L10 =30,000 hours under normal operating conditions.

To replace the internal or external fan, please proceed as following:

- Remove the internal access panel by unscrewing the 10 fixing screws.
- Disconnect the blower cables from the connectors.
- Unscrew the four screws fixing the blower bracket to the cabinet.
- Unscrew the fan from the bracket.
- Re-assembly with the new blower is in reverse order.

Make sure that the blower cable length is the same as the one of the removed fan to ensure that the cable does not come in contact with the blower while in operation. Make sure that the correct polarity is maintained. (Refer to circuit diagram). Inspect and if necessary replace the internal access panel sealing tape.

In addition the unit should have regular functional tests (approx. every 2,000 hours depending on the grade of ambient pollution).

15. Transport & Storage



Malfunction due to transport damage

On delivery the carton containing the unit must be examined for signs of transport damage. Any transport damage to the carton could indicate that the unit itself has been damaged in transit which in the worst case could mean that the unit will not function.

Storage conditions

The unit can only be stored in locations which meet the following conditions:

Temperature range: - 40°C to 70°C

Relative humidity (at 25°C): max. 95%

Returning the unit











Damage to the unit through incorrect transport.

To avoid transport damage the unit should be returned in the original packing or in a packing case and must be strapped to a pallet!

If the unit cannot be returned in the original packing please ensure that:

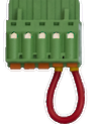
- A space of at least 30 mm. must be maintained at all points between the unit and the external packing.
- The unit must be firmly fixed in the packing.
- The unit must be protected sufficiently by shock absorbing padding (hard foam corner pieces, strips or cardboard corner pieces).

16. Parts supplied / Spare parts / Accessories

Description	QTY	Image
Instruction manual	1	
CE Declaration	1	
Mounting template	1	
M6 x 25 Slotted stud	12	
A6.4 washer	12	
M6 nuts	12	
Cable gland M12 x 1.5	2	
Lock nut M12 x 1.5	2	
5 - pole terminal block for signals	1	
4 - pole terminal block for electrical connection	1	
Drain fitting	1	
Silicone washer	1	

Seifert Systems GmbH
Albert-Einstein-Str. 3

42477 Radevormwald
Germany
Tel.+49 2195 68994-0
info.de@seifertsystems.com

Seifert Systems Ltd.
HF09/10

Hal-Far Industrial Estate
Birzebbuga, BBG 3000
Malta
Tel.+356 2220 7000
info@seifertsystems.com

Seifert Systems AG
Wilerstrasse 16

4563 Gerlafingen
Switzerland
Tel.+41 32 675 35 51
info.ch@seifertsystems.com

Seifert Systems GmbH
Bärnthäl 1

4901 Ottnang
Austria
Tel.+43 7676 20712 0
info.at@seifertsystem.com

Seifert Systems Ltd.
Rep. Office

26100 Cremona
Italy
Tel.+39 349 259 4524
info@seifertsystems.com

Seifert Systems Inc.

75 Circuit Drive
North Kingstown
RI 02852
USA
Tel.+1 401-294-6960
info.us@seifertsystems.com

Seifert Systems Pty Ltd.

105 Lewis Road
Wantirna South
3152 Victoria
Australia
Tel.+61 3 98 01 19 06
info@seifertsystems.com.au